

















ONDERDELENLIJST

Party tent 3x6

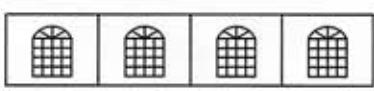
Deze onderdelen worden bij inlevering van de tent terug verwacht.

Aantal	Onderdeel	Omschrijving
8	A 	Spantbuis
9	B 	Nok- en horizontale buis
8	C 	Staanders
8		Voet
6		3-punts koppeling
6		4-punts koppeling
8		Moer en bout
4		Scheerlijnen
42		Bout
82		Elastiek
12		Haring ø7x330mm
72		Haring ø4.5x180mm
2		Korte zijde
2		Lange zijde
1		Dak
4		Stormband
4		Grondhaak

OPZETINSTRUCTIE

Gelieve de tent op te zetten volgens deze instructie



Bos Verhuur

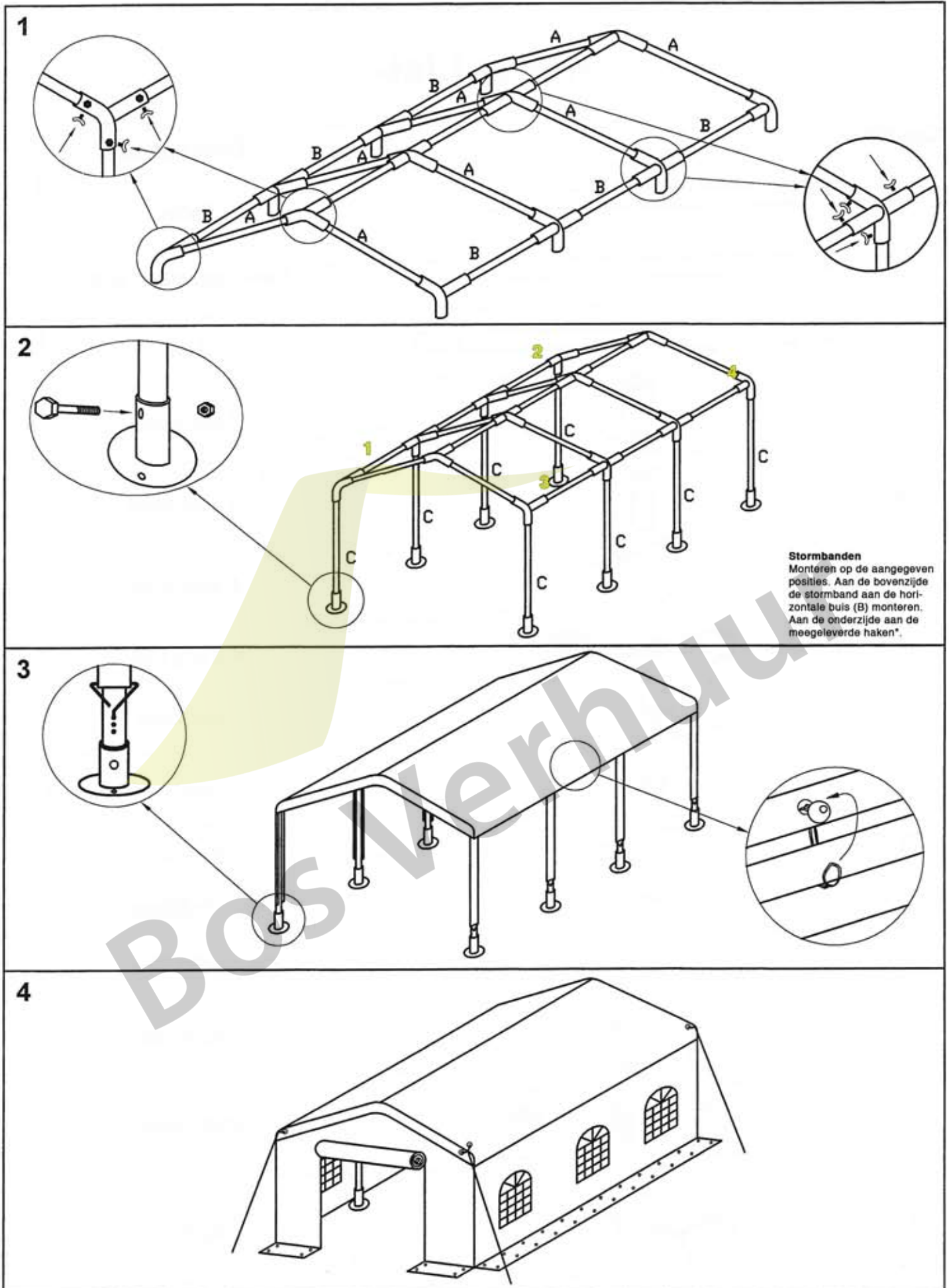

*De meegeleverde haken worden gebruikt indien de tent op straatwerk wordt geplaatst. In dat geval wordt de haak tussen de stenen gedraaid. Wanneer de tent op een zachte ondergrond wordt geplaatst dienen de meegeleverde haringen te worden gebruikt.