

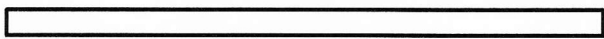

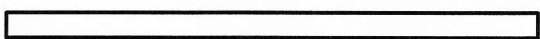











# ONDERDELENLIJST

## Party tent 4x4

Deze onderdelen worden bij inlevering van de tent terug verwacht.

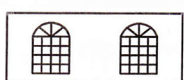
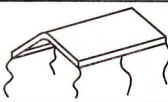
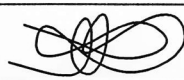
Aantal	Onderdeel	Omschrijving
6	A 	Spantbuis
6	B 	Nok- en horizontale buis
6	C 	Staanders
6		Voet
6		3-punts koppeling
3		4-punts koppeling
6		Moer en bout
4		Scheerlijnen
30		Bout
86		Elastiek
10		Haring ø7x330mm
52		Haring ø4.5x280mm
2		Korte zijde
2		Lange zijde
1		Dak
4		Stormband
4		Grondhaak



# OPZETINSTRUCTIE

Gelieve de tent op te zetten volgens deze instructie

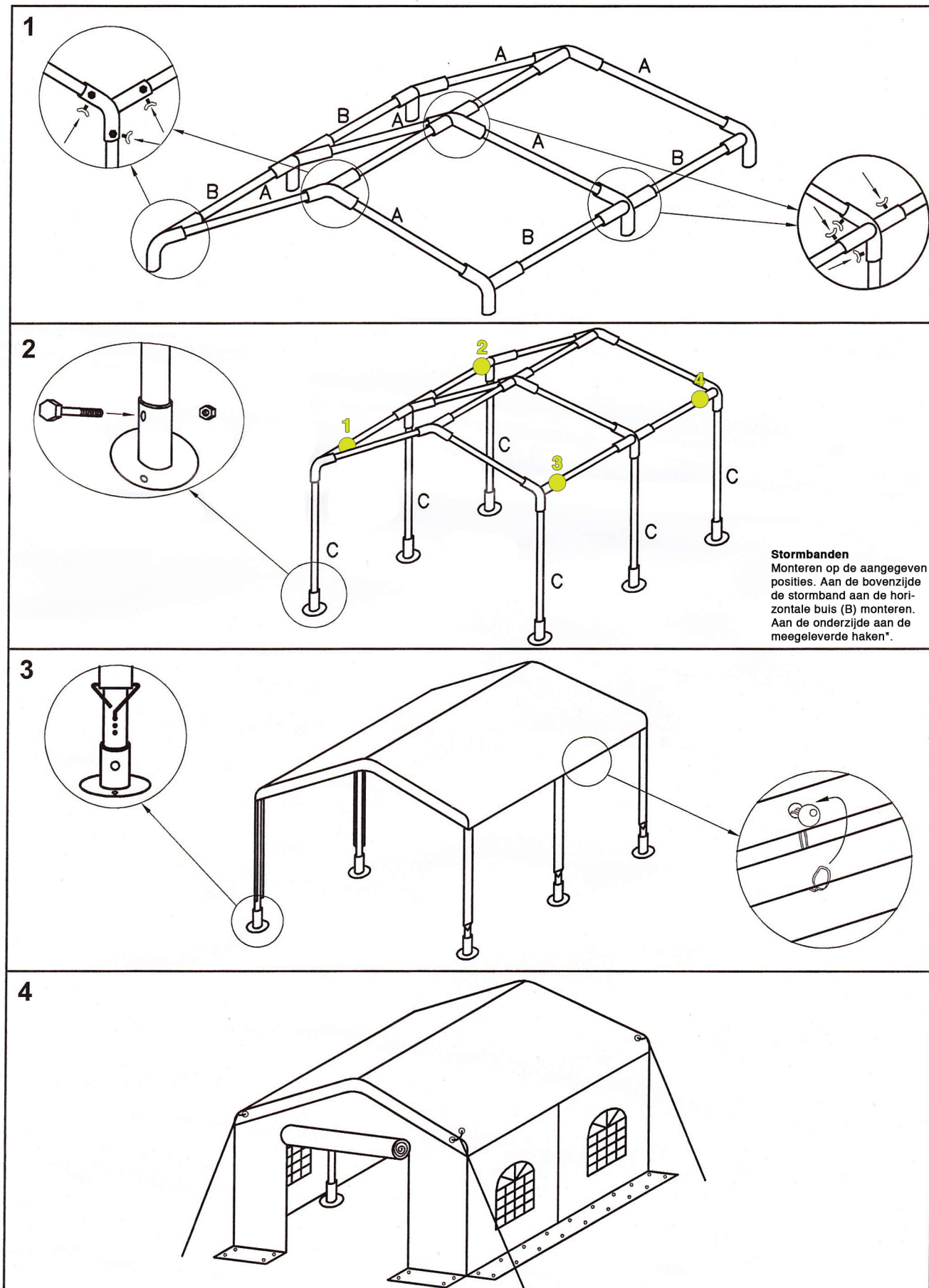

\*De meegeleverde haken worden gebruik indien de tent op straatwerk wordt geplaatst. In dat geval wordt de haak tussen de stenen gedraaid. Wanneer de tent op een zachte ondergrond wordt geplaatst dienen de meegeleverde haringen te worden gebruikt.