

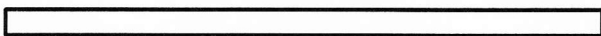

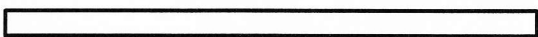













ONDERDELENLIJST

Party tent 4x8

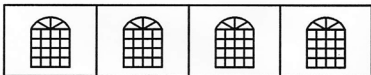
Deze onderdelen worden bij inlevering van de tent terug verwacht.

Aantal	Onderdeel	Omschrijving
10	A 	Spantbuis
12	B 	Nok- en horizontale buis
10	C 	Staanders
10		Voet
6		3-punts koppeling
9		4-punts koppeling
10		Moer en bout
4		Scheerlijnen
54		Bout
118		Elastiek
14		Haring $\varnothing 7 \times 330 \text{mm}$
76		Haring $\varnothing 4.5 \times 280 \text{mm}$
2		Korte zijde
2		Lange zijde
1		Dak
4		Stormband
4		Grondhaak



OPZETINSTRUCTIE

Gelieve de tent op te zetten volgens deze instructie

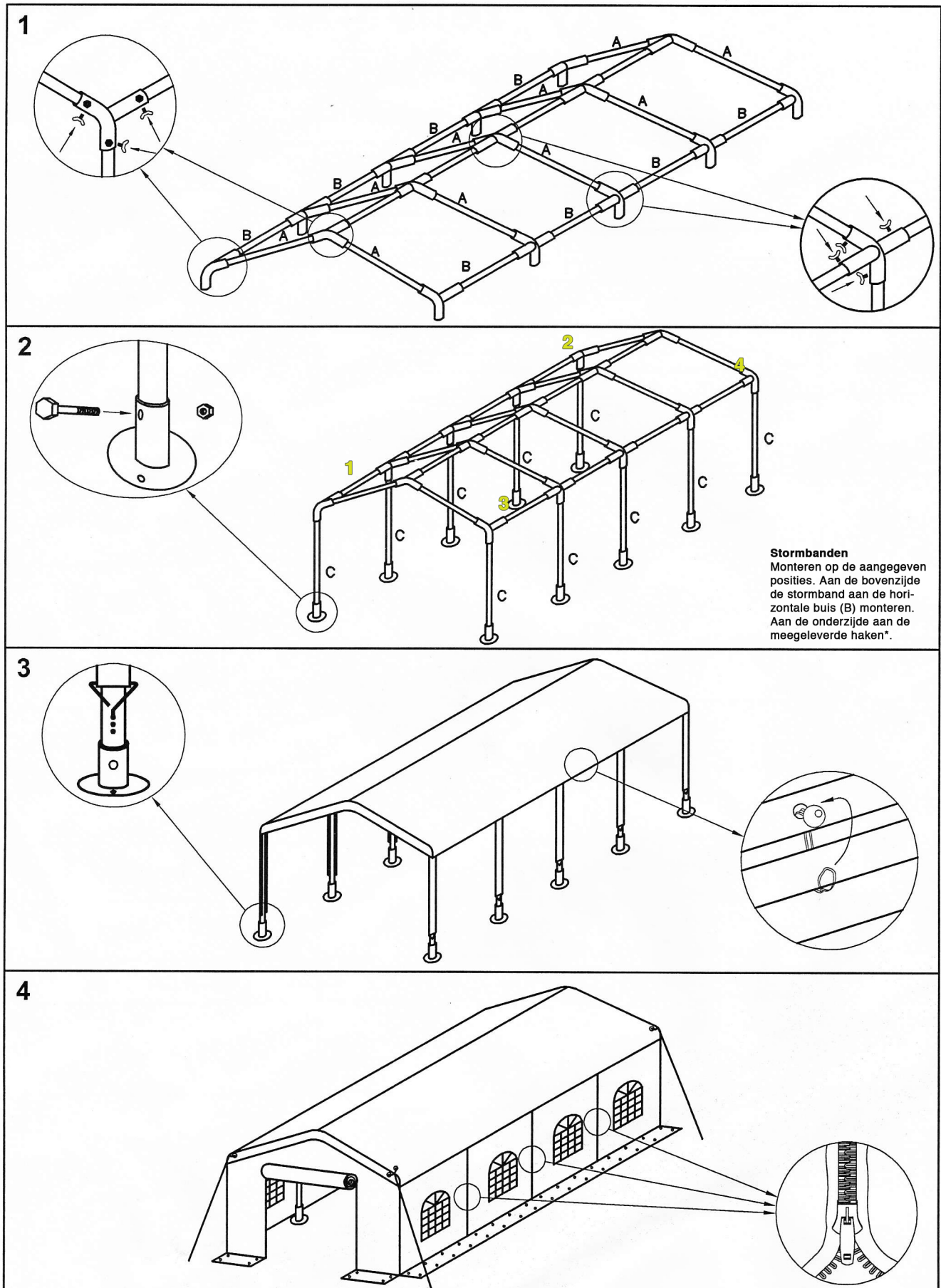

*De meegeleverde haken worden gebruik indien de tent op straatwerk wordt geplaatst. In dat geval wordt de haak tussen de stenen gedraaid. Wanneer de tent op een zachte ondergrond wordt geplaatst dienen de meegeleverde haringen te worden gebruikt.